

TECHNICAL DATA

ROLF BENZ LIV



**ROLF
BENZ**

- Seat made of polyurethane foam, built up in layers and coordinated in different thicknesses and hardnesses, covered with a pad consisting of 20 % viscose foam and 80 % microfibres
- Spring system: Glass fibre-reinforced plastic female connectors
- Back with wooden frame inside
- Back pad in polyurethane foam
- Upholstery cover glued-on non-woven polyester
- Down-like backrest cushions comprising compartments with a filling made of 100 % microfibres and a supporting core made of polyurethane
- Frame Smooth aluminium, powder-coated, matt:
 - RAL 9017 Traffic black
 - RAL 7022 Umbra grey
 - Marrone metallic
- Seat height options 42 cm or 45 cm

Frame:

The frames are available in two depths (84 cm and extradeep 105 cm). Both depths can be combined with each other via the corner or along their length.

The frame is available in: Smooth aluminium, powdercoated, matt:

- RAL 9017 Traffic black
- RAL 7022 Umbra grey
- Marrone metallic

A highquality fibreglass spring system is integrated in the frame.

Seat height optionally:

- 42 cm
- 45 cm

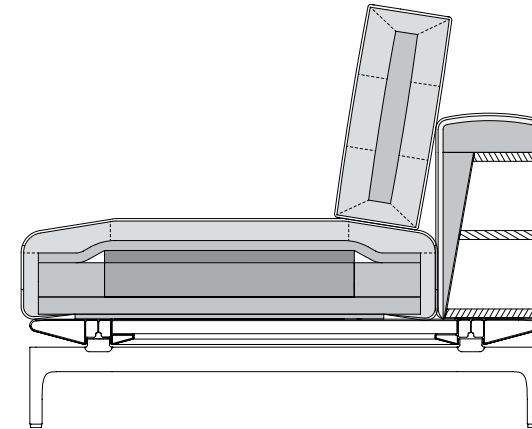

Seat heights available

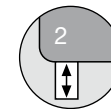

Back/side section widths:

The wide side section is screwed to the frame, whereas the narrow one is screwed to the side of the frame. For this reason, there is a difference in the external dimensions of approx. 4 cm per side when the narrow side section is selected.

! A high-quality, especially casual upholstery that forms waves/leaves indentations that are typical of the material - this waviness may even occur in new condition. All dimensions are approximate and may deviate by up to around 4 cm, or even more in individual cases where elements are connected.

Module: frame + back/side section + seat cushions + back cushions = complete model

Extra deep frame

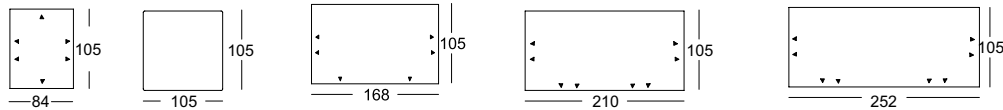

Frame

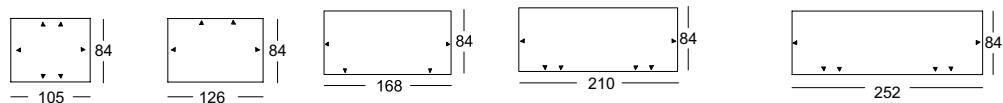

**ROLF
BENZ**

Wide back

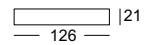
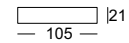
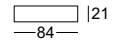

Narrow back

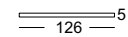
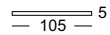

Side element wide

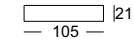
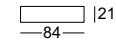

Side element narrow

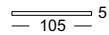

Seat cushion

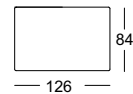
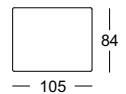
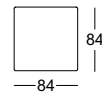

Extra deep seat cushion

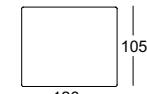
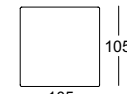
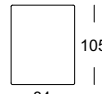

Back cushion

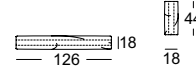
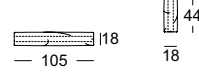
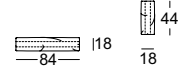
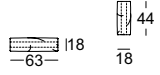
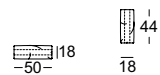
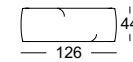
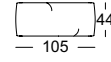

Low back cushion

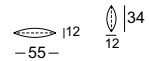

High back cushion

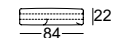
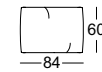

Back cushion with roll

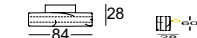
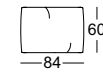

Upholstered roll

